

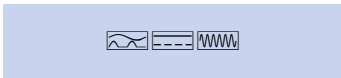

DATA SHEET
residual current monitors
e.Guard RCM B 025
AC/DC sensitive type B
Article number 09344367



Function

RCMs (residual current monitors), when used in combination with separate residual current transformers, allow the monitoring of insulation between active conductors and the earth conductor. In contrast to modular residual current devices (MRCDS) or residual current circuit-breakers (RCCBs), they are used where the system either cannot or should not be switched off. In this way, these devices alone are used to monitor or report residual currents and are therefore suitable for preventative maintenance. They are not suitable for implementing protective measure "Automatic switch-off of power supply" as per DIN VDE 0100-410. Smart, all-current-sensitive residual current monitors (type B) reliably detect fault as well as residual currents and report them without switching off the system. The Ethernet interface transmits the measured residual current values via Modbus TCP protocol. The smart residual current monitors are an integral part of the e.Guard system, regardless of the selected e.Guard LEVEL.

Features

suitable for detecting Type B residual currents, monitored frequency range 0 Hz – 100 kHz, monitored circuit max. 400 V (AC), 63 A, robust plastic housing, easy installation, Configuration of various settings and sending of residual current values over Ethernet, 2 configurable alarm relays with potential-free changeover contacts, Operating voltage from PoE (Power over Ethernet) or direct 24 V DC connection

Mounting

They are attached to a mounting rail.

Applications

The monitoring device is suitable for use in power supplied to purpose-built buildings and industrial facilities with TN-S, TN-C-S networks, IT networks and direct current networks, such as in server rooms for data centres, laboratories, in the automotive industry and in conjunction with photovoltaic and UPS systems with frequency converters without transformers, air conditioning systems, frequency converters, switching power supplies, high-frequency converters, printing machines and packaging machines. , Suitable for monitoring DC circuits and systems in which electronic equipment may generate smooth DC residual currents or residual currents with frequencies not equal to 50 Hz.

Notes

The device is supplied pre-configured and can be commissioned without further settings and operated standalone without e.Guard. Further information is available online: www.eguard.de.

Accessories

interfaces Gateway

Technical Data

Technical Data	e.Guard RCM B 025
Series	e.Guard RCM B 025
Operating mode RCM	standalone
Error memory existent	false
Selectivity adjustable	false
Residual operating current characteristics	B
max. adjustable residual operating current I Δ adj AC	3 A
max. adjustable residual operating current I Δ adj DC	0.3 A

Subject to technical changes

Technical Data	e.Guard RCM B 025
Rated residual operating current I_{Δ}	0.3 A
Rated non-responsive residual current $I_{\Delta no}$	0.15 A
Number of selective frequency ranges	8
Frequency range response residual current Type B	0 Hz ... 100 kHz
Rated voltage U_{em} of circuit monitored AC	0 V ... 400 V
Rated frequency of circuit monitored	50 Hz, 60 Hz
Thermal rated short-time withstand current $I_{\Delta th}$	1.5 kA (1 s)
Thermal rated continuous withstand current $I_{\Delta ch}$	75 A
Control elements	test key
serial interface (Ethernet (LAN))	
Protocols	Modbus TCP
Ethernet rate	10BASE-T, 100BASE-TX
Supply voltage (PoE (Ethernet interface), external adaptor)	
PoE variant	802.3 af (PoE)
Operating voltage (DC)	24 V (21.6 V ... 26.4 V)
Internal consumption	max. 3.5 W
Rated impulse withstand voltage	0.5 kV
Over voltage category	III
Display (operation)	
Number	1
Type	LED (green)
Display (network)	
Type	LED (green)
Display (alarm)	
Type	LED (red, orange)
transformer, primary side	
Rated impulse withstand voltage	4 kV
Rated insulation voltage	400 V
Over voltage category	III when using insulated cables (test voltage ≥ 2 kV AC)
Rated current I_n	63 A
Measurement accuracy	AC/DC: $\pm 5\%$ (from the measuring range end value)
Galvanically separated	false
alarm output	
Specification	relays
Number	2
Response delay relay	$T_v = 0.0$ s (default) - can be adjusted from 0.0 s (default) to 5.0 s in 0.5 s increments (e.Guard) resulting maximum tripping time relay: $T_{max} = T_v + 3.0$ s
Drop delay relay	5 s
Contact assignment	1 CO
Rated voltage (AC)	30 V
Rated voltage (DC)	30 V
Rated current (AC)	1 A
Rated current (DC)	1 A
screw-type terminal (load circuit)	

Subject to technical changes

Technical Data	e.Guard RCM B 025
Allowed types of wires	aluminium conductor, copper conductor
Clamping area	max. 2.5 mm ²
Tightening torque	max. 0.64 Nm
RJ45 (Ethernet connection, power supply)	
Connection design	female
max. Cable length	100 m
General data	
Operating position	optional
max. Operating altitude above MSL	2000 m
Storage temperature	-40 °C ... 60 °C
Ambient temperature	-25 °C ... 55 °C
Housing type	wall-mounted housing
Installation type	Mounting rail (35 mm)
Housing material	polycarbonate (PC)
Protection class	IP20 (installed: IP40)
sealable	false
Width	89 mm
Height	91 mm
Depth	66 mm
Installation depth	59 mm
Module widths	5
Weight	0.294 kg
Inside diameter	25 mm
Design requirements/Standards	DIN VDE 0664-400 (VDE 0664-400) 2012-05, DIN EN IEC 60664-1 (VDE 0110-1) 2022-07, IEEE Std 802.3af 2003, DIN EN IEC 61000-6-4 (VDE 0839-6-4) 2020-09, DIN EN IEC 62020-1 (VDE 0663-1) 2021-10
Degree of pollution	2

Dimensions

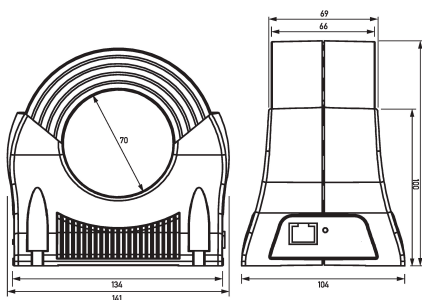

Dimensional drawing Group view

Wiring example

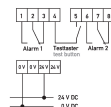

Wiring diagram

Diagrams

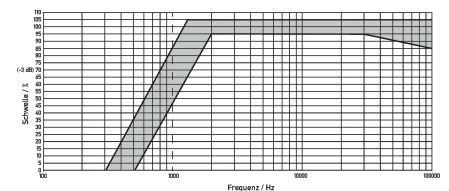
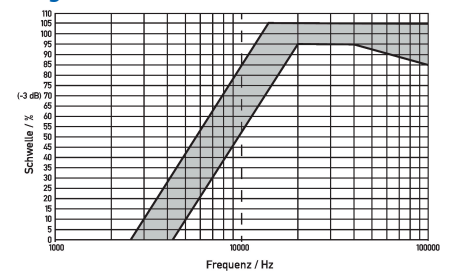

Subject to technical changes

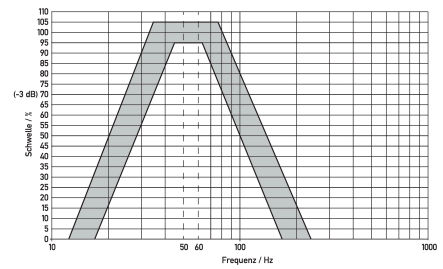
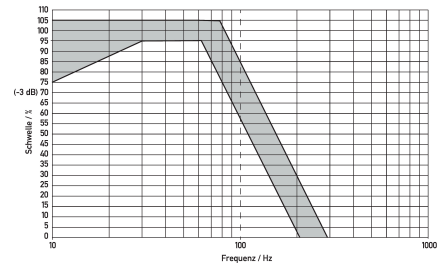
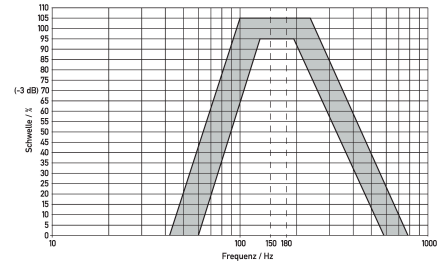
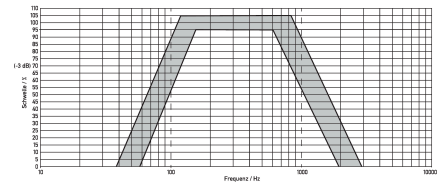

Characteristic Frequency response 50–60 Hz (band-pass)

Characteristic Frequency response < 100 Hz (low-pass/-3 db)

Characteristic Frequency response 150–180 Hz (band-pass)

Characteristic Frequency response 100–1 kHz (band-pass)

Characteristic Frequency response > 1 kHz (high-pass/-3 dB)

Characteristic Frequency response > 10 kHz (high-pass/-3 dB)